

R-001				R0.5D1
Cod	A	B	C	Pret
R1-30.	30	30	7	37
R1-40.	40	40	8	65
R1-50.	50	50	9	102
R1-60.	60	60	10	148
R1-70.	70	70	11	201
R1-80.	80	80	12	264

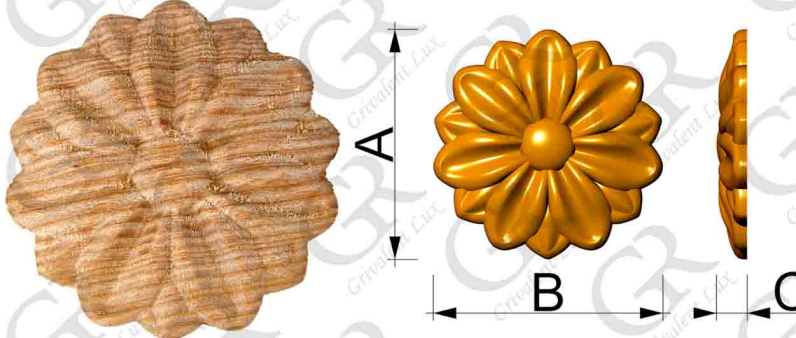

R-002				R0.5D1
Cod	A	B	C	Pret
R2-30.	30	30	7	37
R2-40.	40	40	8	65
R2-50.	50	50	9	102
R2-60.	60	60	10	148
R2-70.	70	70	11	201
R2-80.	80	80	12	264

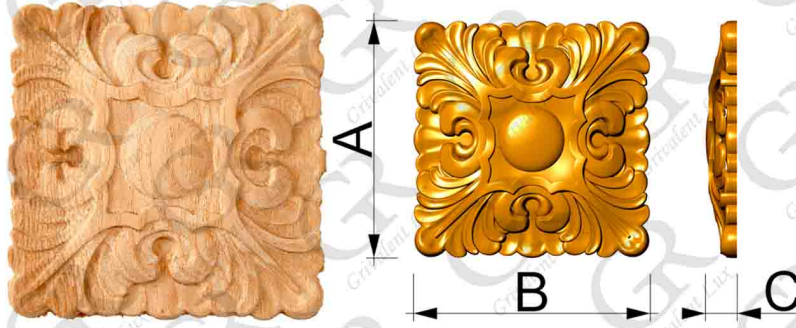

R-003				R0.5D1
Cod	A	B	C	Pret
R3-40.	40	40	8	65
R3-50.	50	50	9	102
R3-60.	60	60	10	148
R3-70.	70	70	11	201
R3-80.	80	80	12	264

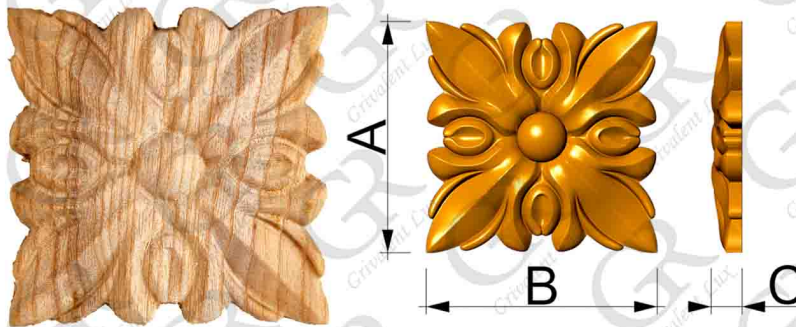

R-004				R0.5D1
Cod	A	B	C	Pret
R4-30.	30	30	7	37
R4-40.	40	40	8	65
R4-50.	50	50	9	102
R4-60.	60	60	10	148
R4-70.	70	70	11	201
R4-80.	80	80	12	264

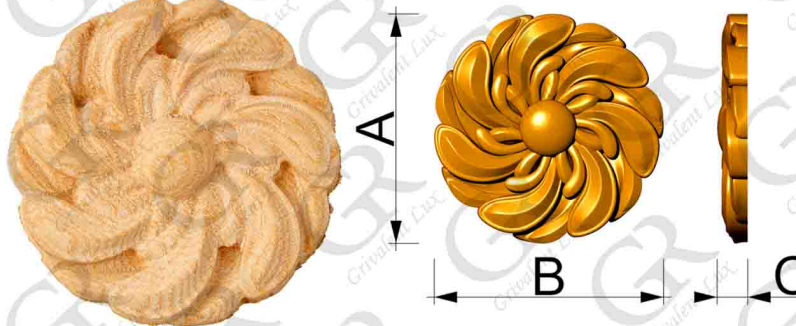

R-005				R0.5D1
Cod	A	B	C	Pret
R5-30.	30	30	7	37
R5-40.	40	40	8	65
R5-50.	50	50	9	102
R5-60.	60	60	10	148
R5-70.	70	70	11	201
R5-80.	80	80	12	264

R-006				R0.5D1
Cod	A	B	C	Pret
R6-30.	30	30	7	37
R6-40.	40	40	8	65
R6-50.	50	50	9	102
R6-60.	60	60	10	148
R6-70.	70	70	11	201
R6-80.	80	80	12	264

R-007				R0.5D1
Cod	A	B	C	Pret
R7-40.	40	40	7	65
R7-50.	50	50	9	102
R7-60.	60	60	10	148
R7-70.	70	70	11	201
R7-80.	80	80	12	264

R-008				R0.5D1
Cod	A	B	C	Pret
R8-30.	30	30	7	37
R8-40.	40	40	8	65
R8-50.	50	50	9	102
R8-60.	60	60	10	148
R8-70.	70	70	11	201
R8-80.	80	80	12	264

R-009				R0.5D1
Cod	A	B	C	Pret
R9-30.	30	30	7	37
R9-40.	40	40	8	65
R9-50.	50	50	9	102
R9-60.	60	60	10	148
R9-70.	70	70	11	201
R9-80.	80	80	12	264

R-010				R0.5D1
Cod	A	B	C	Pret
R10-30.	30	30	7	37
R10-40.	40	40	8	65
R10-50.	50	50	9	102
R10-60.	60	60	10	148
R10-70.	70	70	11	201
R10-80.	80	80	12	264

R-011				R0.5D1
Cod	A	B	C	Pret
R11-30.	30	30	7	37
R11-40.	40	40	8	65
R11-50.	50	50	9	102
R11-60.	60	60	10	148
R11-70.	70	70	11	201
R11-80.	80	80	12	264

R-012				R0.5D1
Cod	A	B	C	Pret
R12-30.	30	30	7	37
R12-40.	40	40	8	65
R12-50.	50	50	9	102
R12-60.	60	60	10	148
R12-70.	70	70	11	201
R12-80.	80	80	12	264

R-013				R0.5D1
Cod	A	B	C	Pret
R13-50.	50	50	15	104
R13-60.	60	60	16	150
R13-70.	70	70	17	204
R13-80.	80	80	18	268

R-014				R0.5D1
Cod	A	B	C	Pret
R14-30.	30	30	7	37
R14-40.	40	40	8	65
R14-50.	50	50	9	102
R14-60.	60	60	10	148
R14-70.	70	70	11	201
R14-80.	80	80	12	264

KL-001				R0.5D1
Cod	A	B	C	Pret
KL1-50.	50	52	12	107
KL1-60.	60	62	13	154
KL1-70.	70	72	14	209
KL1-80.	80	82	15	272

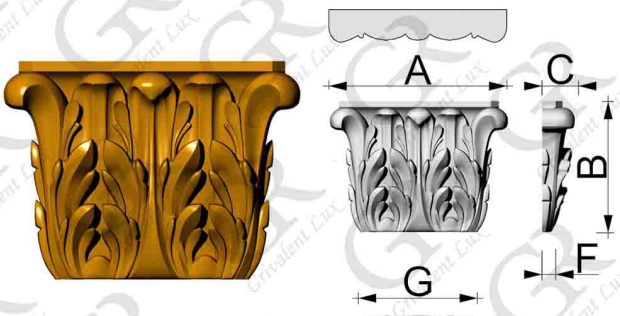

KL-002				R0.5D1
Cod	A	B	C	Pret
KL2-50.	50	37	12	76
KL2-60.	60	44	13	109
KL2-70.	70	52	14	151
KL2-80.	80	60	15	199



KL-003				R0.5D1
Cod	A	B	C	Pret
KL3-50.	50	40	12	82
KL3-60.	60	48	13	119
KL3-70.	70	56	14	162
KL3-80.	80	64	15	212

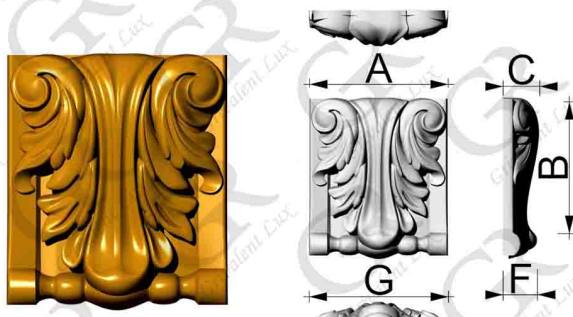

KL-004				R0.5D1
Cod	A	B	C	Pret
KL4-50.	50	58	13	120
KL4-60.	60	70	15	174
KL4-70.	70	80	17	234
KL4-80.	80	90	19	302

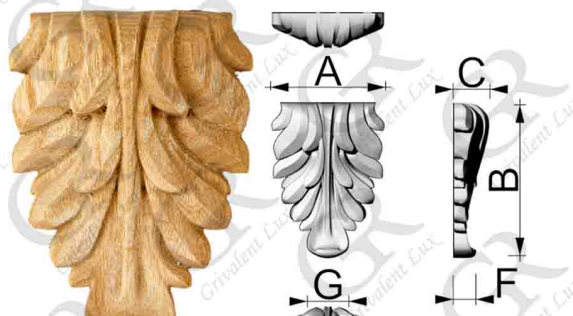

KL-005				R0.5D1
Cod	A	B	C	Pret
KL5-50.	50	67	12	138
KL5-60.	60	81	14	201
KL5-70.	70	94	16	274
KL5-80.	80	108	19	362

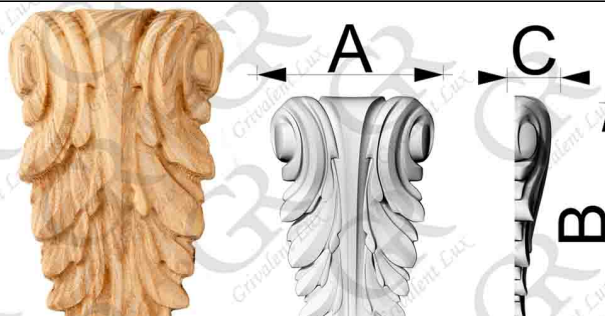

KL-006				R0.5D1
Cod	A	B	C	Pret
KL6-50.	50	80	17	167
KL6-60.	60	95	19	239
KL6-70.	70	110	22	325
KL6-80.	80	127	25	432

KL-007				R1.5D3
Cod	A	B	C	Pret
KL7-50.	50	90	25	508
KL7-60.	60	110	30	759
KL7-70.	70	130	35	1061
KL7-80.	80	150	40	1416
KL7-90.	90	170	45	1823
KL7-100.	100	190	50	2284

KL-008				R1.5D3
Cod	A	B	C	Pret
KL8-50.	50	70	25	328
KL8-60.	60	90	30	535
KL8-70.	70	110	35	793
KL8-80.	80	130	40	1102
KL8-90.	90	150	45	1465
KL8-100.	100	170	50	1880

KL-009				R1.5D3
Cod	A	B	C	Pret
KL9-50.	50	60	25	252
KL9-60.	60	80	30	437
KL9-70.	70	100	35	673
KL9-80.	80	120	40	960
KL9-90.	90	140	45	1300
KL9-100.	100	160	50	1693

KL-010				R1.5D3
Cod	A	B	C	Pret
KL10-50.	50	80	25	77
KL10-60.	60	100	30	100
KL10-70.	70	120	35	126
KL10-80.	80	140	40	158
KL10-90.	90	160	45	193
KL10-100.	100	180	50	233

KL-011				R0.5D1
Cod	A	B	C	Pret
KL11-50.	50	53	10	109
KL11-60.	60	64	12	158
KL11-70.	70	74	14	214
KL11-80.	80	85	16	283

	KL-012				R0.5D1
	Cod	A	B	C	Pret
	KL12-50.	50	96	12	198
	KL12-60.	60	116	14	288
	KL12-70.	70	135	16	393
	KL12-80.	80	154	18	515

	DC-001				R1D2
	Cod	A	B	C	Pret
	DC1-300.	300	70	12	697
	DC1-400.	400	90	14	1202
	DC1-500.	500	110	16	1848
	DC1-600.	600	130	18	2636
	DC1-700.	700	150	20	3570
	DC1-800.	800	170	22	4651

	DC-002				R1D2
	Cod	A	B	C	Pret
	DC2-300.	300	60	12	598
	DC2-400.	400	80	14	1069
	DC2-500.	500	100	16	1680
	DC2-600.	600	120	18	2434
	DC2-700.	700	140	20	3332
	DC2-800.	800	160	22	4378

	DC-003				R1D2
	Cod	A	B	C	Pret
	DC3-300.	300	50	12	498
	DC3-400.	400	60	14	802
	DC3-500.	500	70	16	1176
	DC3-600.	600	80	18	1622
	DC3-700.	700	90	20	2142
	DC3-800.	800	100	22	2736

	DC-004				R1D2
	Cod	A	B	C	Pret
	DC4-300.	300	96	10	950
	DC4-400.	400	127	14	1697
	DC4-500.	500	158	17	2662
	DC4-600.	600	190	20	3876
	DC4-700.	700	223	23	5354
	DC4-800.	800	254	26	7031

				DC-005			R1D2
				Cod	A	B	C
DC5-300.	300	62	12		618		
DC5-400.	400	82	16		1102		
DC5-500.	500	103	20		1751		
DC5-600.	600	123	21		2517		
DC5-700.	700	144	22		3447		
DC5-800.	800	164	23		4500		

					P1				R1.5D3
					Cod	H	T	B	C
PM1-74T11.	740	110	87	97		1441			
PM1-74T16.	740	160	87	97		1441			
PM1-74T20.	740	200	87	97		1441			
PM1-74T25.	740	250	87	97		1441			
PT1-50T20.	500	200	63	70		620			
PT1-50T36.	500	360	63	70		620			
PJ1-50T7.	500	70	85	95		944			
PK1-40T28.	400	280	77	88		667			
PK1-34T16.	340	160	77	88		567			
PS1-43T6.	430	60	61	69		516			
PU1-90T76.	900	760	68	75		1231			
C1-90.	900	-	45	73		933			
P1-20T6.	200	60	68	75		274			
P1-17T5.	170	50	70	63		211			
P1-14T4.	140	40	70	63		173			
P1-17.	170	-	95	85		321			
P1-14.	140	-	95	85		264			
P1-12.	120	-	80	75		184			
P1-10.	100	-	68	63		121			



P2					R1.5D3
Cod	H	T	B	C	Pret
PM2-74T11.	740	110	86	93	1387
PM2-74T16.	740	160	86	93	1387
PM2-74T20.	740	200	86	93	1387
PM2-74T25.	740	250	86	93	1387
PT2-50T20.	500	200	63	70	620
PT2-50T36.	500	360	63	70	620
PJ2-50T7.	500	70	85	95	944
PK2-40T28.	400	280	77	88	667
PK2-34T16.	340	160	77	88	567
PS2-43T6.	430	60	61	69	516
PU2-90T76.	900	760	68	75	1231
C2-90.	900	-	45	73	933
P2-20T6.	200	60	75	70	279
P2-17T5.	170	50	67	72	224
P2-14T4.	140	40	63	70	173
P2-17.	170	-	100	90	347
P2-14.	140	-	84	75	222
P2-12.	120	-	84	75	190
P2-10.	100	-	63	70	124

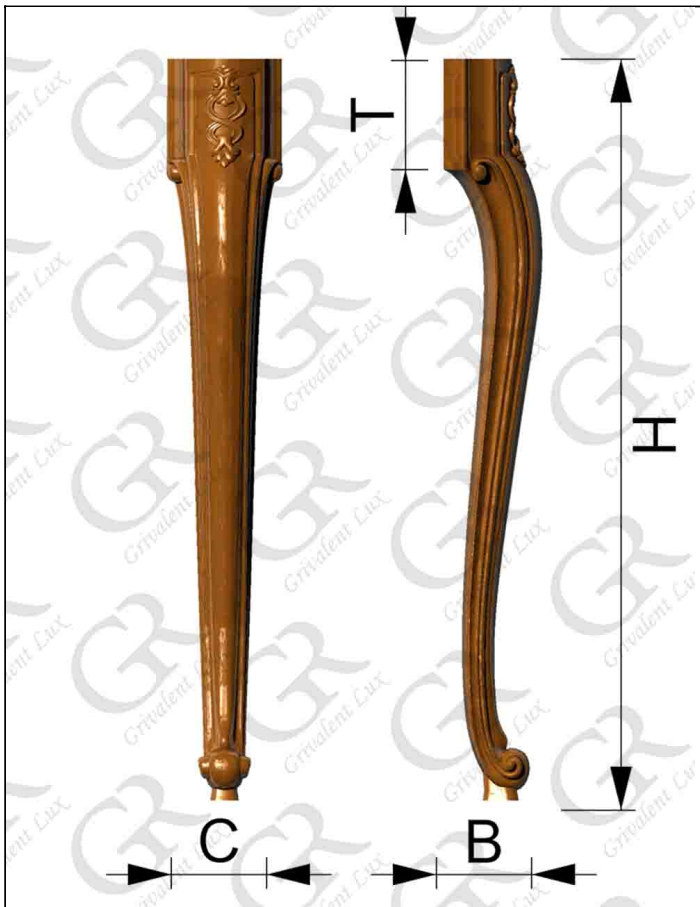

P3					R1.5D3
Cod	H	T	B	C	Pret
PM3-74T11.	740	110	98	94	1534
PM3-74T16.	740	160	98	94	1534
PM3-74T20.	740	200	98	94	1534
PM3-74T25.	740	250	98	94	1534
PM3-74T30.	740	300	98	94	1534
PT3-50T10.	500	100	73	70	685
PT3-50T20.	500	200	73	70	685
PT3-50T36.	500	360	73	70	685
PJ3-50T7.	500	70	99	95	1052
PK3-40T28.	400	280	83	105	800
PK3-34T16.	340	160	83	105	680
PS3-43T6.	430	60	68	70	561
P3-20T6.	200	60	78	96	359
P3-17T5.	170	50	68	83	250
P3-14T4.	140	40	63	77	186
P3-17.	170	-	93	93	337
P3-14.	140	-	85	85	244
P3-12.	120	-	75	75	176
P3-10.	100	-	72	72	138

P4						R1.5D3
Cod	H	T	B	C	<i>Pret</i>	
P4-8.	80	-	55	57	79	
P4-10.	100	-	64	67	121	
P4-12.	120	-	71	75	169	
P4-14.	140	-	75	80	214	
P4-17.	170	-	90	95	334	

P5						R1.5D3
Cod	H	T	B	C	<i>Pret</i>	
P5-20T6.	200	60	82	95	368	
P5-17T5.	170	50	72	83	260	
P5-14T4.	140	40	70	77	199	
P5-17.	170	-	85	95	321	
P5-14.	140	-	71	85	216	
P5-12.	120	-	64	75	158	
P5-10.	100	-	58	72	119	

P5F						R1.5D3
Cod	H	T	B	C	<i>Pret</i>	
P5F-20T6.	200	60	82	95	368	
P5F-17T5.	170	50	72	83	260	
P5F-14T4.	140	40	70	77	199	
P5F-17.	170	-	85	95	321	
P5F-14.	140	-	71	85	216	
P5F-12.	120	-	64	75	158	
P5F-10.	100	-	58	72	119	

P6						R1.5D3
Cod	H	T	B	C	<i>Pret</i>	
PM6-74T11.	740	110	93	93	1466	
PJ6-50T7.	500	70	80	80	800	
PS6-43T6.	430	60	70	70	572	



P7					R1.5D3
Cod	H	T	B	C	Pret
PM7-74T11.	740	110	70	70	984
PJ7-50T7.	500	70	60	60	540
PS7-43T6.	430	60	50	50	366

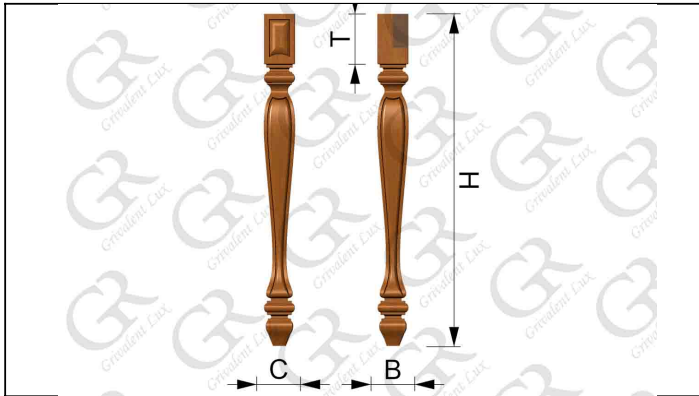

P8					R1.5D3
Cod	H	T	B	C	Pret
PM8-74T11.	740	110	70	70	984
PJ8-50T7.	500	70	60	60	540
PS8-43T6.	430	60	50	50	366

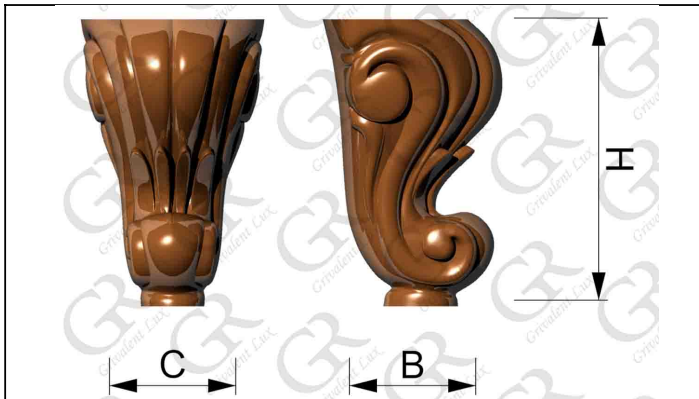

P9					R1.5D3
Cod	H	T	B	C	Pret
P9-10.	100	-	65	65	120
P9-12.	120	-	75	75	176
P9-14.	140	-	88	88	256
P9-17.	170	-	95	95	347

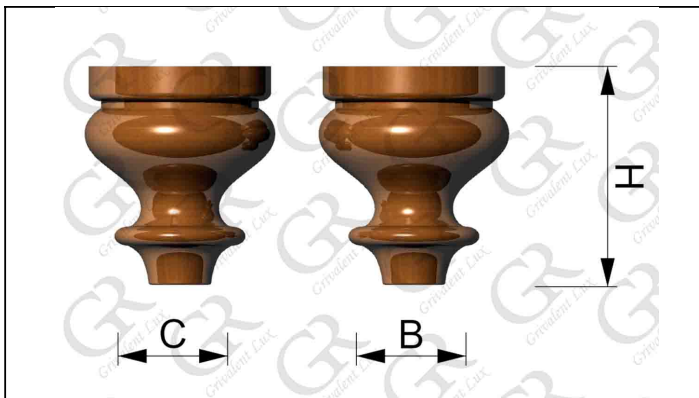

P10					R1.5D3
Cod	H	T	B	C	Pret
P10-8.	80	-	70	70	106
P10-10.	100	-	75	75	146
P10-12.	120	-	80	80	192
P10-14.	140	-	85	85	244



P12					R1.5D3
Cod	H	T	B	C	Pret
PM12-74T11.	740	110	75	75	1082
PJ12-50T7.	500	70	60	60	540
PS12-43T6.	430	60	50	50	366
P12-14.	140	-	95	95	286
P12-12.	120	-	90	90	227
P12-10.	100	-	85	85	174
P12-8.	80	-	80	80	119

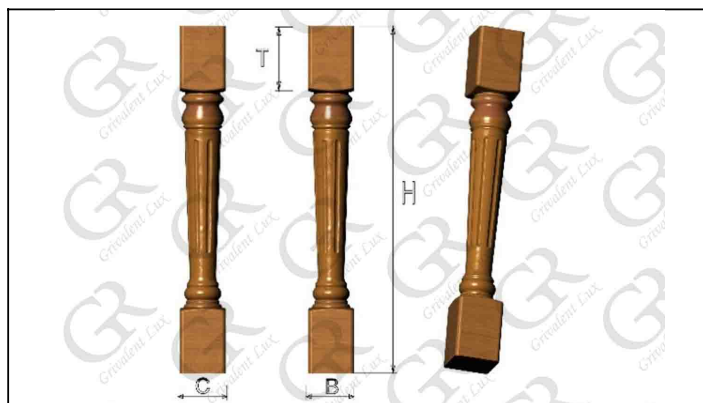

CO1					R1.5D3
Cod	H	T	B	C	Pret
CO1-90M12.	900	160	120	120	2592
CO1-90M10.	900	160	100	100	1980
CO1-90M8.	900	160	80	80	1440
CO1-90M6.	900	160	60	60	972
CO1-90M4.	900	160	40	40	576

Cornișă 98mm MDF C98

Buc

Pret

2176

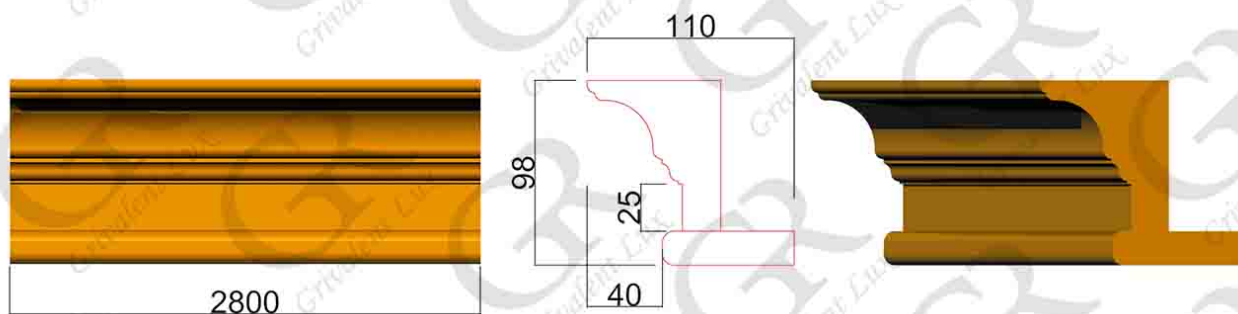

Cornișă 98mm MDF C98P

Buc

Pret

2646

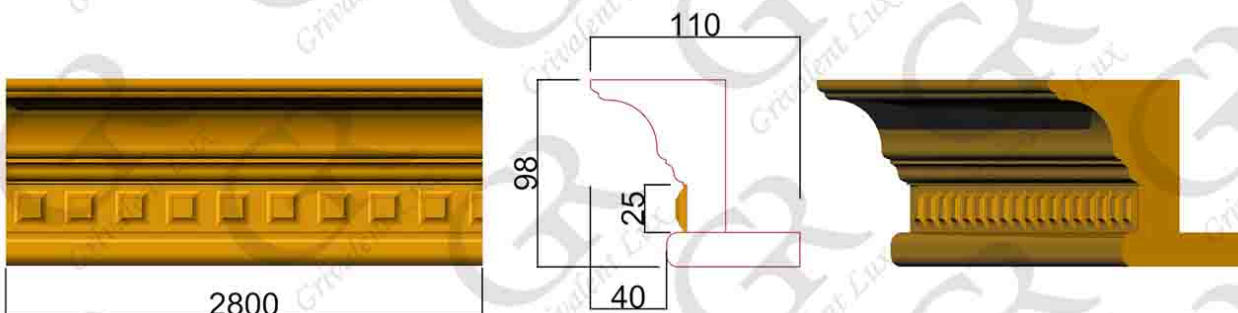

Cornișă 98mm MDF C98L

Buc

Pret

2646

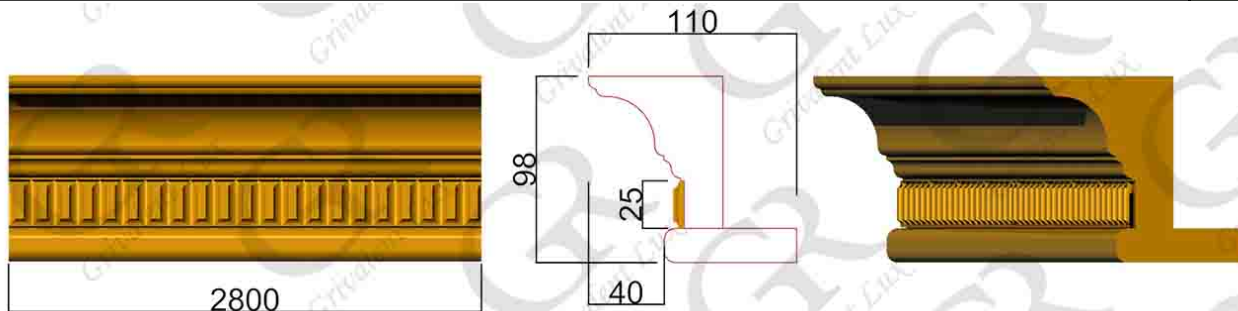

Cornișă 98mm MDF C98M

Buc

Pret

2646

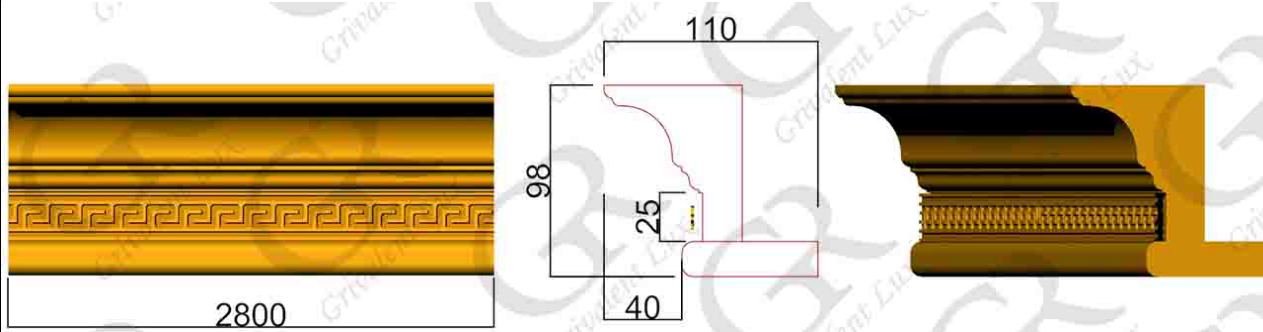

Cornișă 70mm MDF C70		Buc	Pret 1554

Cornișă 54mm MDF C54		Buc	Pret 1478